

33.306X

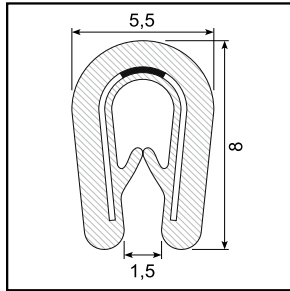

Edge trim: PVC black
Grip range: 0.8 - 1.5 mm
Hardness: SH 78
Insert: 15 x 0,3 mm steel

33.307A

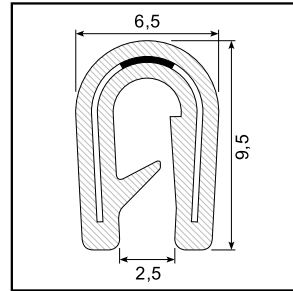

Edge trim: PVC black
Grip range: 1 - 2 mm
Hardness: SH 75
Insert: 17,5 x 0,3 mm steel
On cardboard coil

33.409 / 33.401G

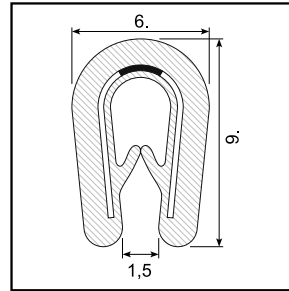

Edge trim: PVC black
Grip range: 1 - 2 mm
Hardness: SH 78
Insert: 16 x 0,3 mm steel
33.401G (grey)

33.410X

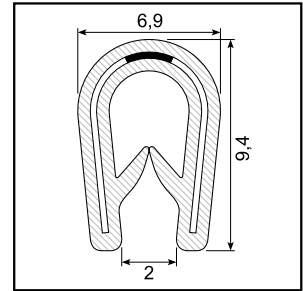

Edge trim: PVC black
Grip range: 1 - 2 mm
Hardness: SH 75
Insert: 17,5 x 0,3 mm steel

33.422

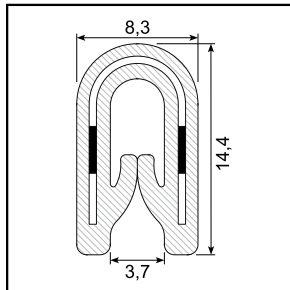

Edge trim: TPE flexible
Grip range: 1 - 2,5 mm
Hardness: SH 82
Insert: 25 x 0,48 mm steel

33.310X

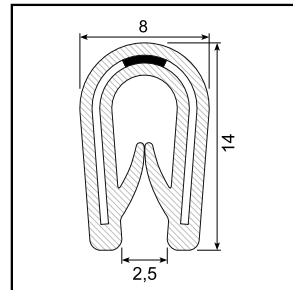

Edge trim: PVC black
Grip range: 1 - 3 mm
Hardness: SH 75
Insert: 26 x 0,47 mm steel

33.310SS

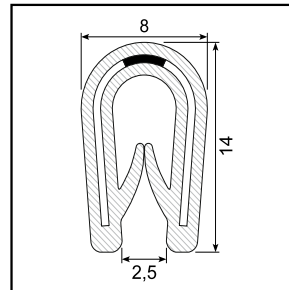

Edge trim: PVC black
Grip range: 1 - 2,5 mm
Hardness: SH 70 - 75
Insert: 26 x 0,5 mm stainless steel

33.308A

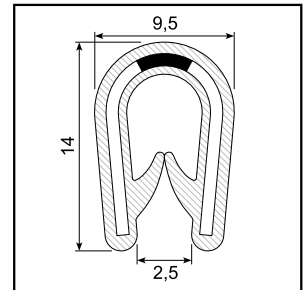

Edge trim: PVC black
Grip range: 1 - 2,5 mm
Hardness: SH 75
Insert: 26 x 0,47 mm steel
On cardboard coil

33.420X

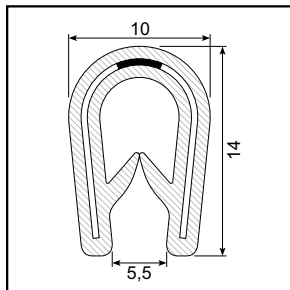

Edge trim: PVC black
Grip range: 1 - 4 mm
Hardness: SH 75
Insert: 27 x 0,47 mm steel

33.419

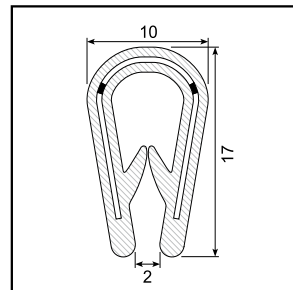

Edge trim: PVC black
Grip range: 1 - 4 mm
Hardness: SH 78
Insert: 31 x 0,5 mm steel

33.411

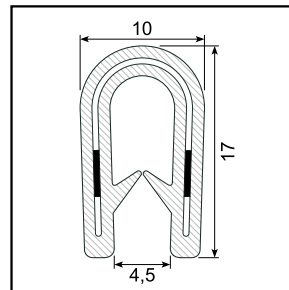

Edge trim: PVC grey
Grip range: 2,5 - 4 mm
Hardness: SH 78
Insert: 29 x 0,48 mm steel

33.411A

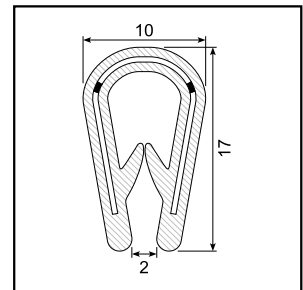

Edge trim: PVC grey
Grip range: 1 - 4 mm
Hardness: SH 78
Insert: 31 x 0,5 mm steel
Min. order: 2.000 mtr.

33.425 / 33.425G

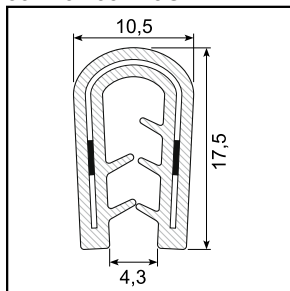

Edge trim: PVC
Grip range: 3 - 4 mm
Hardness: SH 78
Insert: 35 x 0,48 mm steel
33.425G (grey)

33.418X

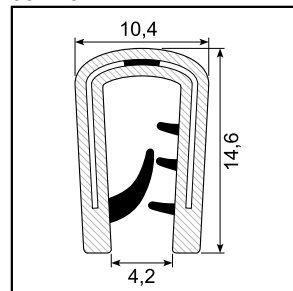

Edge trim: PVC black+bi
Grip range: 2 - 5 mm
Hardness: SH 75 / 75
Insert: 26 x 0,47 mm steel
White lips

33.418RX

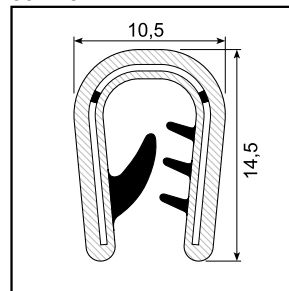

Edge trim: PVC black+bi
Grip range: 2 - 5 mm
Hardness: SH 78 / 65
Insert: 31 x 0,5 mm stainless steel
Transparent lips

33.427X

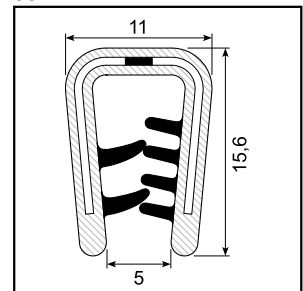

Edge trim: PVC black+bi
Grip range: 1,5 - 4,5 mm
Hardness: SH 75 / 75
Insert: 30 x 0,47 mm steel
Yellow lips

33.094X

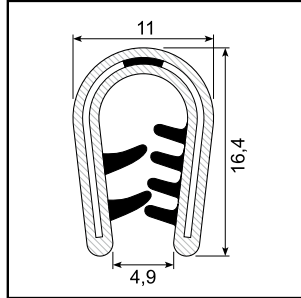

Edge trim: PVC Black+bi
Grip range: 1 - 4 mm
Hardness: SH 75 / 75
Insert: 30 x 0,47 mm steel
Yellow lips

33.1153 / 33.1153G

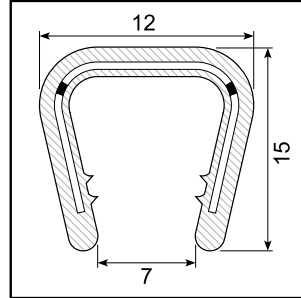

Edge trim: PVC Black
Grip range: 6 - 8 mm
Hardness: SH 78
Insert: 31 x 0,5 mm steel
33.1153G (grey)

33.428 / 33.428G

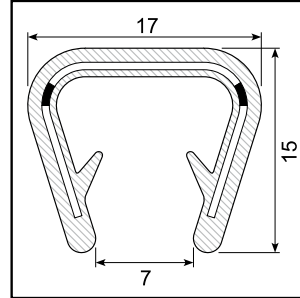

Edge trim: PVC Black
Grip range: 10 - 12 mm
Hardness: SH 78
Insert: 36 x 0,5 mm steel
33.428G (grey)

33.1154

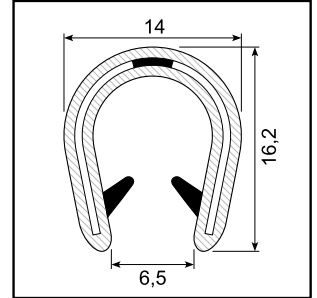

Edge trim: PVC Black
Grip range: 6 - 8 mm
Hardness: SH 75 / 75
Insert: 30 x 0,47 mm steel
Min. order: 5.000 mtr.
White lips

33.415

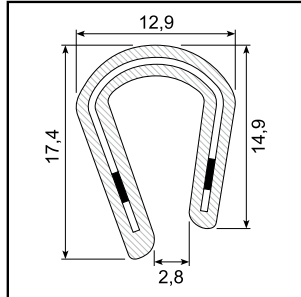

Edge trim: PVC
Grip range: 5 - 7 mm
Hardness: SH 78
Insert: 29 x 0,48 mm steel

33.1155

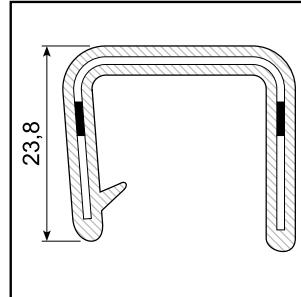

Edge trim: PVC Black
Grip range: 15 - 16 mm
Hardness: SH 85
Insert: Steel
On demand

33.1156

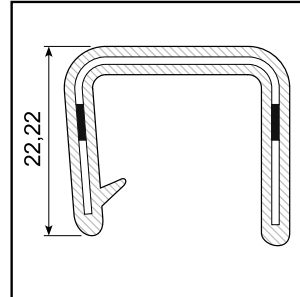

Edge trim: PVC Black
Grip range: 18 - 19 mm
Hardness: SH 85
Insert: Steel
On demand

33.426 / 33.426G

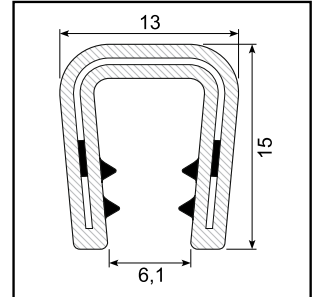

Edge trim: PVC+bi
Grip range: 4,5 - 7 mm
Hardness: SH 78 / 65
Insert: 29 x 0,48 mm steel

33.432

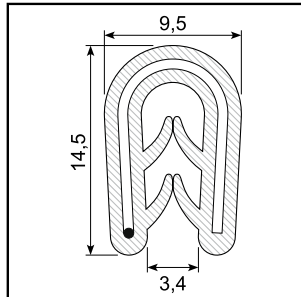

Edge trim: EPDM
Grip range: 1 - 3 mm
Hardness: SH 65
Insert: 27 mm wire
Min. order: 5.000 mtr.

33.434

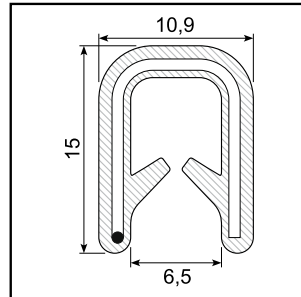

Edge trim: EPDM
Grip range: 2 - 4 mm
Hardness: SH 65
Insert: 30 mm wire
Min. order: 4.000 mtr.

33.433F

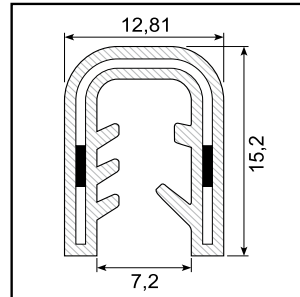

Edge trim: EPDM
Grip range: 4 - 6 mm
Hardness: SH 70
Insert: 36 x 0,5 mm steel
Flame retardent EPDM

33.435

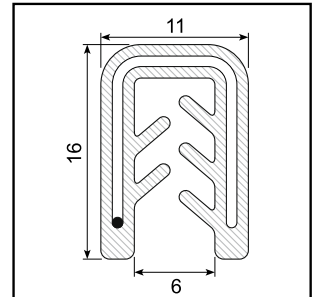

Edge trim: EPDM
Grip range: 3 - 5 mm
Hardness: SH 70
Insert: 31 x 0,76 mm wire
Min. order: 5.000 mtr.

33.311

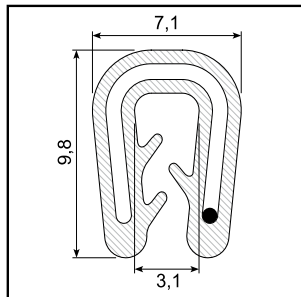

Edge trim: Silikone
Grip range: 1 - 2 mm
Hardness: SH 60
Insert: 18 x 0,76 mm wire
Heat resistant 200°C

33.312

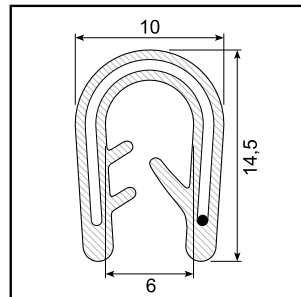

Edge trim: Silikone
Grip range: 2 - 4 mm
Hardness: SH 60
Insert: 26 x 0,76 mm wire
Heat resistant 200°C

33.429

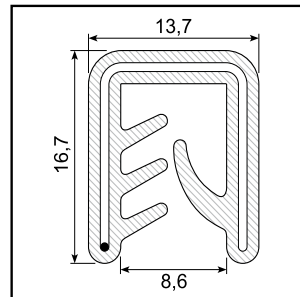

Edge trim: Silikone
Grip range: 5 - 7 mm
Hardness: SH 60
Insert: 39 x 0,76 mm wire
Heat resistant 200°C

33.417

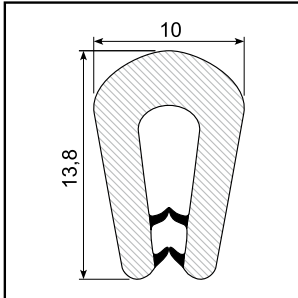

Edge trim: TPE+bi
Grip range: 1 - 4,5 mm
Hardness: SH 87 / 65 - 70
Insert: No steel inserts

33.417A

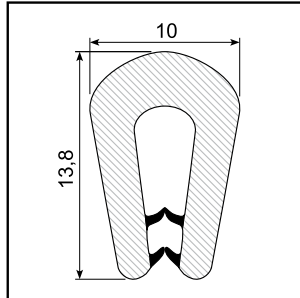

Edge trim: TPE+bi
Grip range: 1 - 4,5 mm
Hardness: SH 80 / 65 - 70
Insert: No steel inserts
On demand

33.424

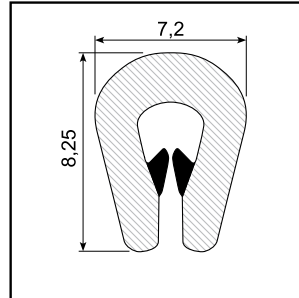

Edge trim: TPE+bi
Grip range: 0,8 - 2,5 mm (1,5 - 3 mm)
Hardness: SH 87 / 65 - 70
Insert: No steel inserts

33.409ABS

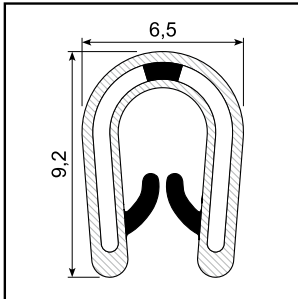

Edge trim: PVC + bi
Grip range: 0,5 - 3 mm
Hardness: SH 75 / 57
Insert: ABS Plastic
No rust - easy cutting

33.308ABS

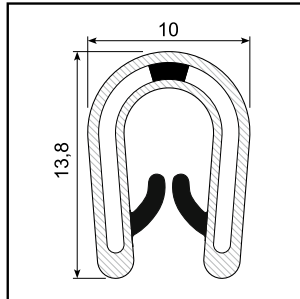

Edge trim: PVC + bi
Grip range: 2 - 5 mm
Hardness: SH 75 / 57
Insert: ABS plastic
No rust - easy cutting



33.500

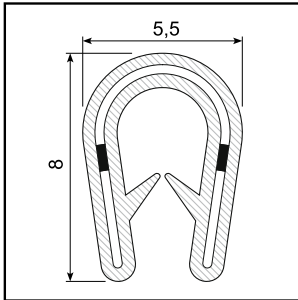

Edge trim: PVC Black
Grip range: 1 - 2 mm
Hardness: SH 70
Insert: 16 x 0,3 mm steel
Min. order: min. 4.000 mtr.

33.501

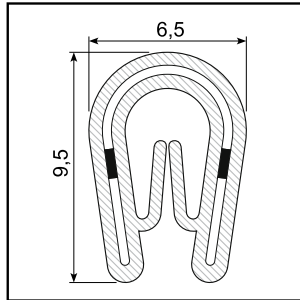

Edge trim: PVC Black
Grip range: 1 - 2 mm
Hardness: SH 70
Insert: 21 x 0,3 mm steel
Min. order: 4.000 mtr.

33.502

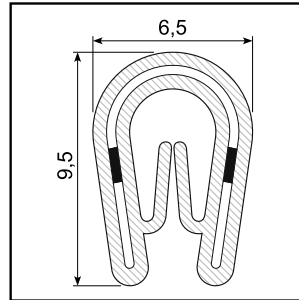

Edge trim: PVC Black
Grip range: 1 - 2 mm
Hardness: SH 70
Insert: 21 x 0,3 mm steel
Min. order: 4.000 mtr.
Flame retardent Din 5510-2

33.503

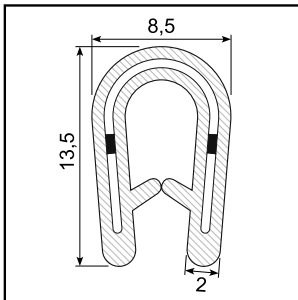

Edge trim: EPDM
Grip range: 1 - 3 mm
Hardness: SH 60
Insert: 33 x 0,5 mm steel
Min. order: 4.000 mtr.

33.504

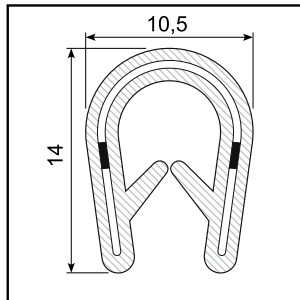

Edge trim: PVC black
Grip range: 1 - 4 mm
Hardness: SH 70
Insert: 33 x 0,5 mm steel
Min. order: 4.000 mtr.

33.505

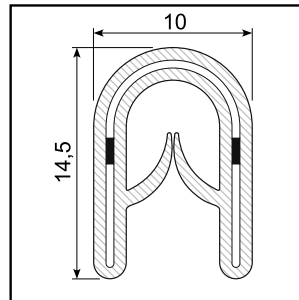

Edge trim: EPDM
Grip range: 1 - 4 mm
Hardness: SH 70
Insert: 33 x 0,5 mm steel
Min. order: 4.000 mtr.

33.094X

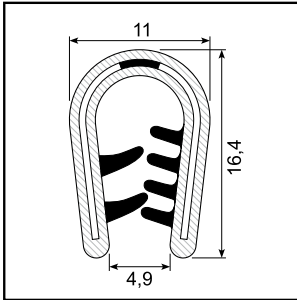

Edge trim: PVC Black+bi
Grip range: 1 - 4 mm
Hardness: SH 75 / 75
Insert: 30 x 0,47 mm steel
Yellow lips

33.1153 / 33.1153G

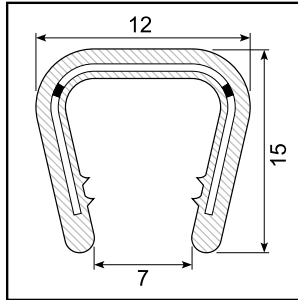

Edge trim: PVC Black
Grip range: 6 - 8 mm
Hardness: SH 78
Insert: 31 x 0,5 mm steel
33.1153G (grey)

33.428 / 33.428G

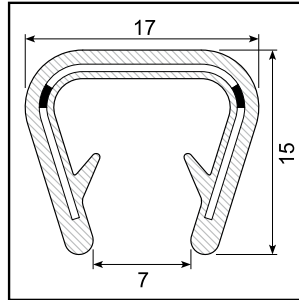

Edge trim: PVC Black
Grip range: 10 - 12 mm
Hardness: SH 78
Insert: 36 x 0,5 mm steel
33.428G (grey)

33.1154

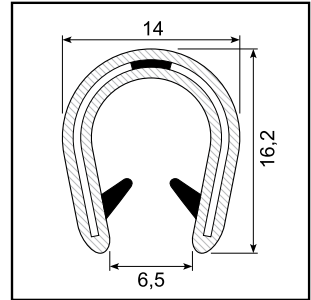

Edge trim: PVC Black
Grip range: 6 - 8 mm
Hardness: SH 75 / 75
Insert: 30 x 0,47 mm steel
Min. order: 5.000 mtr.
White lips

33.415

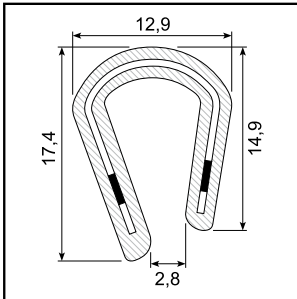

Edge trim: PVC
Grip range: 5 - 7 mm
Hardness: SH 78
Insert: 29 x 0,48 mm steel

33.1155

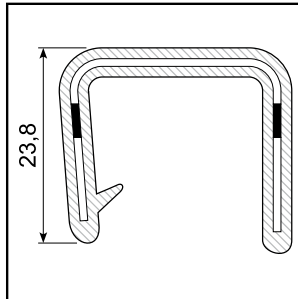

Edge trim: PVC Black
Grip range: 15 - 16 mm
Hardness: SH 85
Insert: Steel
On demand

33.1156

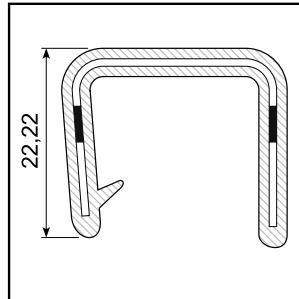

Edge trim: PVC Black
Grip range: 18 - 19 mm
Hardness: SH 85
Insert: Steel
On demand

33.426 / 33.426G

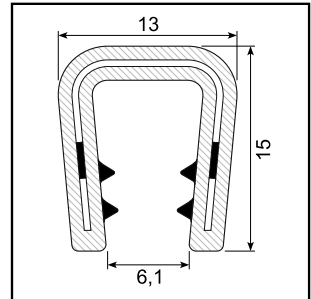

Edge trim: PVC+bi
Grip range: 4,5 - 7 mm
Hardness: SH 78 / 65
Insert: 29 x 0,48 mm steel

33.432

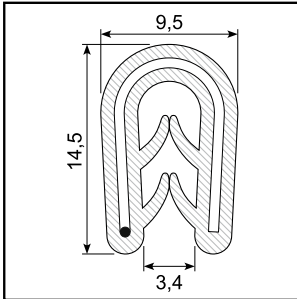

Edge trim: EPDM
Grip range: 1 - 3 mm
Hardness: SH 65
Insert: 27 mm wire
Min. order: 5.000 mtr.

33.434

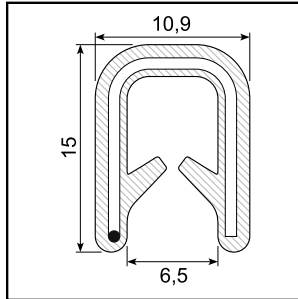

Edge trim: EPDM
Grip range: 2 - 4 mm
Hardness: SH 65
Insert: 30 mm wire
Min. order: 4.000 mtr.

33.433F

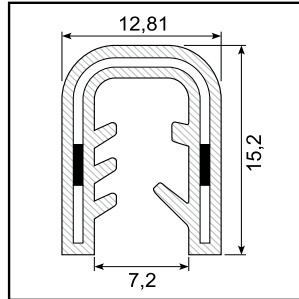

Edge trim: EPDM
Grip range: 4 - 6 mm
Hardness: SH 70
Insert: 36 x 0,5 mm steel
Flame retardent EPDM

33.435

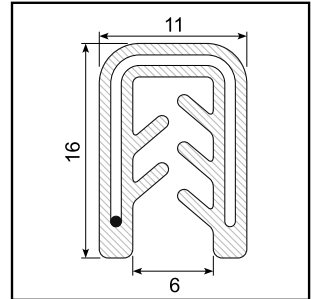

Edge trim: EPDM
Grip range: 3 - 5 mm
Hardness: SH 70
Insert: 31 x 0,76 mm wire
Min. order: 5.000 mtr.

33.311

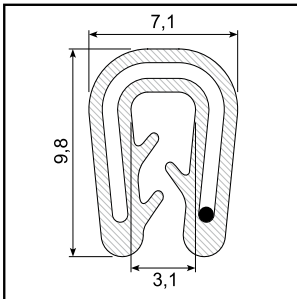

Edge trim: Silikone
Grip range: 1 - 2 mm
Hardness: SH 60
Insert: 18 x 0,76 mm wire
Heat resistant 200°C

33.312

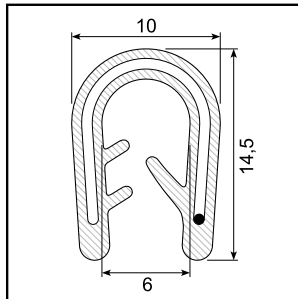

Edge trim: Silikone
Grip range: 2 - 4 mm
Hardness: SH 60
Insert: 26 x 0,76 mm wire
Heat resistant 200°C

33.429

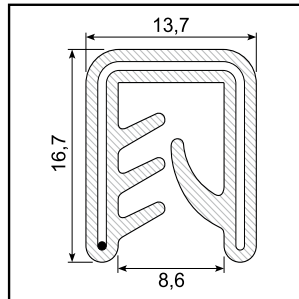

Edge trim: Silikone
Grip range: 5 - 7 mm
Hardness: SH 60
Insert: 39 x 0,76 mm wire
Heat resistant 200°C

33.417

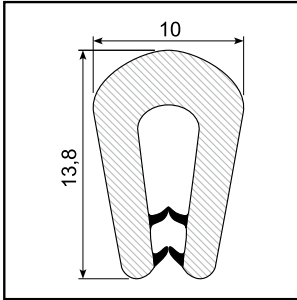

Edge trim: TPE+bi
Grip range: 1 - 4,5 mm
Hardness: SH 87 / 65 - 70
Insert: No steel inserts

33.417A

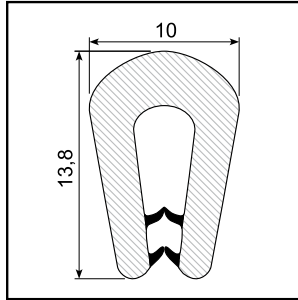

Edge trim: TPE+bi
Grip range: 1 - 4,5 mm
Hardness: SH 80 / 65 - 70
Insert: No steel inserts
On demand

33.424

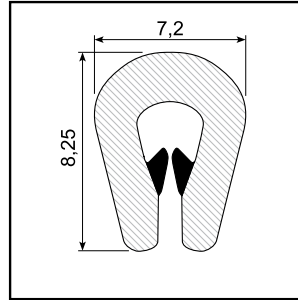

Edge trim: TPE+bi
Grip range: 0,8 - 2,5 mm (1,5 - 3 mm)
Hardness: SH 87 / 65 - 70
Insert: No steel inserts

33.409ABS

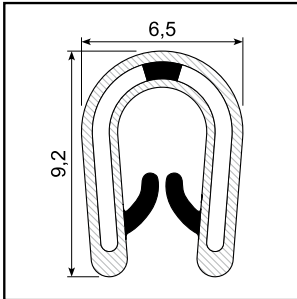

Edge trim: PVC + bi
Grip range: 0,5 - 3 mm
Hardness: SH 75 / 57
Insert: ABS Plastic
No rust - easy cutting

33.308ABS

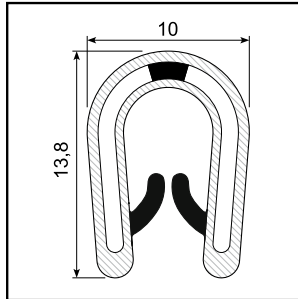

Edge trim: PVC + bi
Grip range: 2 - 5 mm
Hardness: SH 75 / 57
Insert: ABS plastic
No rust - easy cutting



33.500

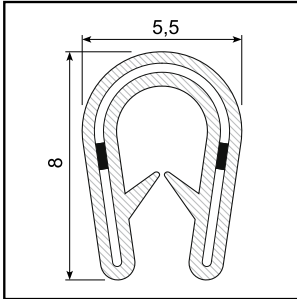

Edge trim: PVC Black
Grip range: 1 - 2 mm
Hardness: SH 70
Insert: 16 x 0,3 mm steel
Min. order: min. 4.000 mtr.

33.501

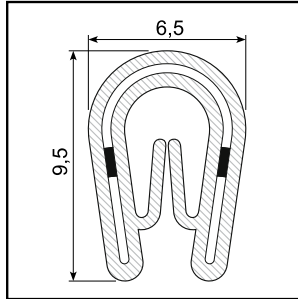

Edge trim: PVC Black
Grip range: 1 - 2 mm
Hardness: SH 70
Insert: 21 x 0,3 mm steel
Min. order: 4.000 mtr.

33.502

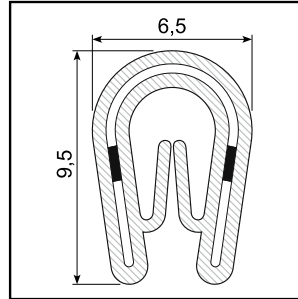

Edge trim: PVC Black
Grip range: 1 - 2 mm
Hardness: SH 70
Insert: 21 x 0,3 mm steel
Min. order: 4.000 mtr.
Flame retardent Din 5510-2

33.503

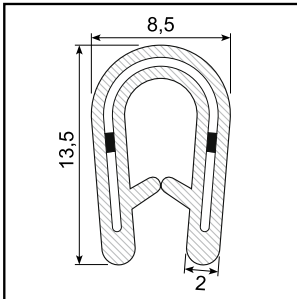

Edge trim: EPDM
Grip range: 1 - 3 mm
Hardness: SH 60
Insert: 33 x 0,5 mm steel
Min. order: 4.000 mtr.

33.504

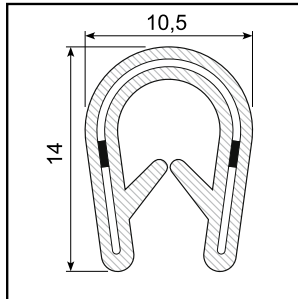

Edge trim: PVC black
Grip range: 1 - 4 mm
Hardness: SH 70
Insert: 33 x 0,5 mm steel
Min. order: 4.000 mtr.

33.505

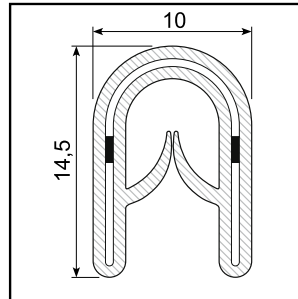

Edge trim: EPDM
Grip range: 1 - 4 mm
Hardness: SH 70
Insert: 33 x 0,5 mm steel
Min. order: 4.000 mtr.

33.354

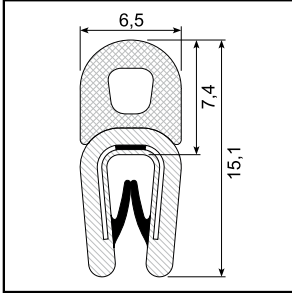

Edge trim: PVC+bi / sponge rubber
Grip range: 1 - 2 mm
Hardness: SH78/57 / density 0,55
Insert: 16 x 0,3 mm steel

33.468X

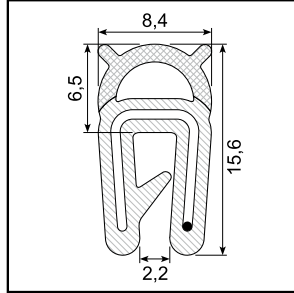

Edge trim: EPDM co-ex
Grip range: 1 - 2 mm
Hardness: SH 60 / density 0,55
Insert: 22 x 0,75 mm wire

33.468B

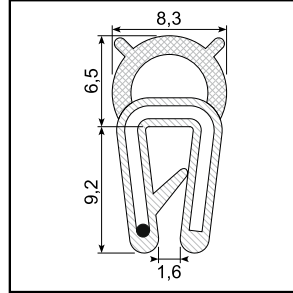

Edge trim: EPDM co-ex
Grip range: 1 - 2 mm
Hardness: SH 70 / density 0,55
Insert: 22 mm wire
Min. order: 3.000 mtr.

33.368

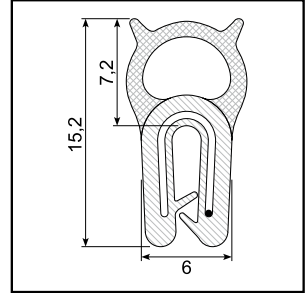

Edge trim: EPDM co-ex
Grip range: 0,5 - 1,5 mm
Hardness: SH 60 / density 0,55
Insert: wire
Min. order: 6.000 mtr.

33.021

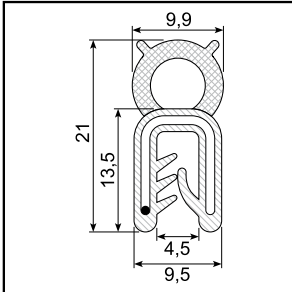

Edge trim: EPDM co-ex
Grip range: 0,8 - 2 mm
Hardness: SH 70 / density 0,55
Insert: 25 mm wire

33.358A

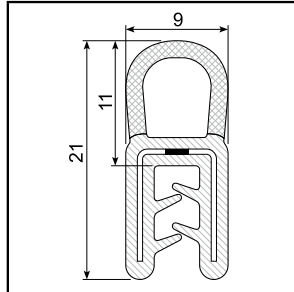

Edge trim: EPDM co-ex
Grip range: 1 - 3,5 mm (1 - 3 mm)
Hardness: SH 70 / density 0,55
Insert: 26 x 0,5 mm
Unbroken

33.358B

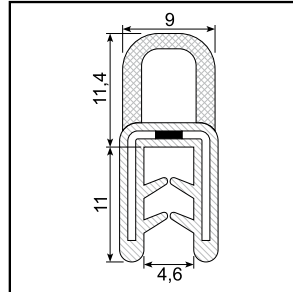

Edge trim: EPDM co-ex
Grip range: 1 - 3 mm
Hardness: SH 70 / density 0,55
Insert: 27 mm steel
Min. order: 4.000 mtr.

33.358C

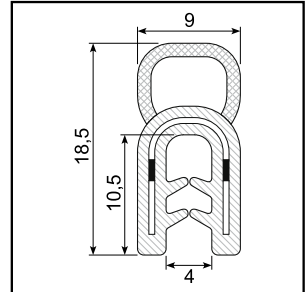

Edge trim: EPDM co-ex
Grip range: 0,8 - 2,5 mm
Hardness: SH 65
Insert: 25 x 0,5 mm steel
Min. order: 3.000 mtr.

33.370NBR

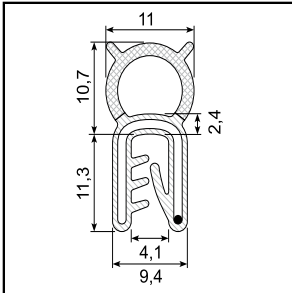

Edge trim: NBR co-ex
Grip range: 1 - 3 mm
Hardness: SH 70 / density 0,55
Insert: Wire
Oil resistant

33.371X

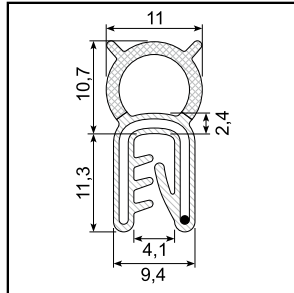

Edge trim: EPDM co-ex
Grip range: 1 - 3,5 mm (1 - 3 mm)
Hardness: SH 70 / density 0,55
Insert: 27 mm wire

33.369

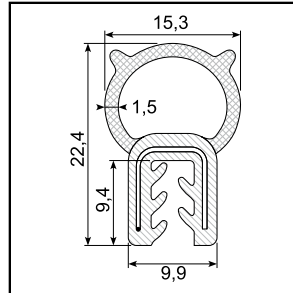

Edge trim: EPDM co-ex
Grip range: 2 - 4 mm
Hardness: SH 65 / density 0,6
Insert: Wire

33.469X

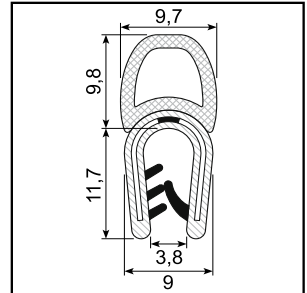

Edge trim: PVC+bi / sponge rubber
Grip range: 1,5 - 3,5 mm
Hardness: SH 75 / 63
density 0,6 - 0,85
Insert: 26 x 0,47 mm steel

33.353

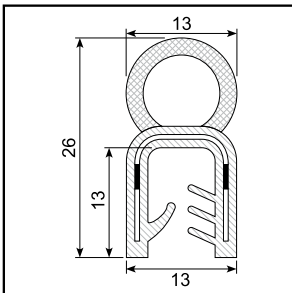

Edge trim: EPDM co-ex
Grip range: 3 - 5 mm
Hardness: SH 65 / density 0,6
Insert: 33 mm steel

33.357

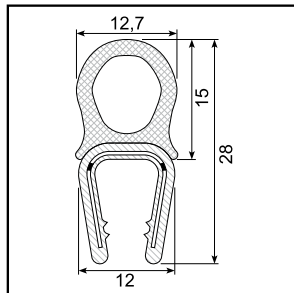

Edge trim: PVC / sponge rubber
Grip range: 5 - 7 mm
Hardness: SH 78 / density 0,6
Insert: 31 x 0,5 mm

33.352

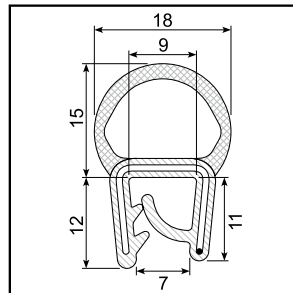

Edge trim: EPDM co-ex
Grip range: 5 - 6 mm
Hardness: SH 78 / density 0,6
Insert: 31 x 0,5 mm

33.359X

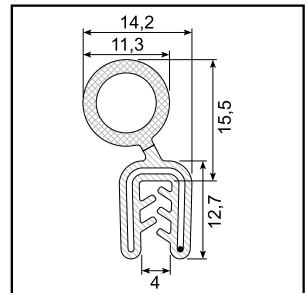

Edge trim: EPDM co-ex
Grip range: 1,5 - 4 mm
Hardness: SH 70 /
density 0,6 - 0,85
Insert: 25 wire

33.365X

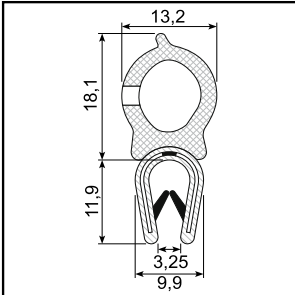

Edge trim: PVC+bi sponge rubber
Grip range: 1 - 4 mm
Hardness: SH75 / 63 / density 0,6 - 0,85
Insert: 26 x 0,47 mm steel

33.376

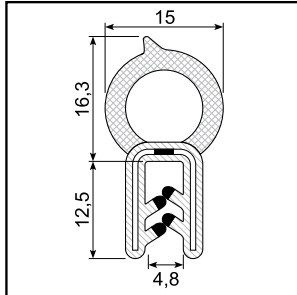

Edge trim: EPDM co-ex
Grip range: 1 - 3,5 mm
Hardness: SH 70 / density 0,75
Insert: 27 mm steel
Min. order: 5.000 mtr.

33.360

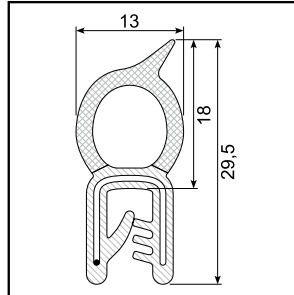

Edge trim: EPDM co-ex
Grip range: 1 - 4 mm
Hardness: SH 60 / density 0,55
Insert: 27 x 0,76 mm wire

33.360R

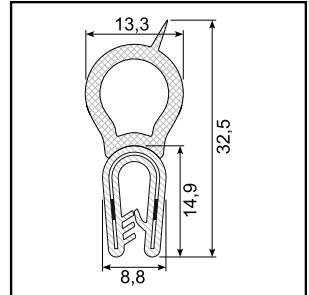

Edge trim: EPDM co-ex
Grip range: 1 - 4 mm
Hardness: SH 60 / density 0,55
Insert: 27 x 0,76 mm wire

33.361

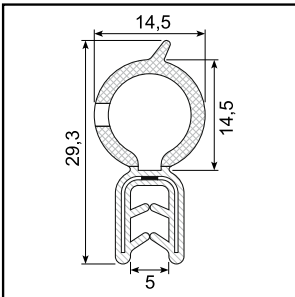

Edge trim: EPDM co-ex
Grip range: 1 - 4 mm
Hardness: SH 70 / density 0,55
Insert: 26 x 0,5 mm steel
Min. order: 5.500 mtr.

33.361B

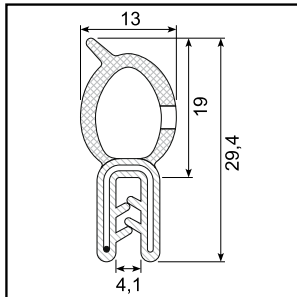

Edge trim: EPDM co-ex
Grip range: 1 - 2,5 mm
Hardness: SH 65 / density 0,55
Insert: 26 x 0,76 mm wire
Min. order: 5.500 mtr.

33.362

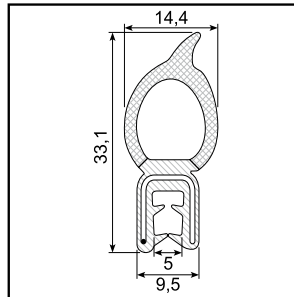

Edge trim: EPDM co-ex
Grip range: 1 - 3,5 mm
Hardness: SH 70 / density 0,6
Insert: 26 x 0,76 mm wire

33.362B

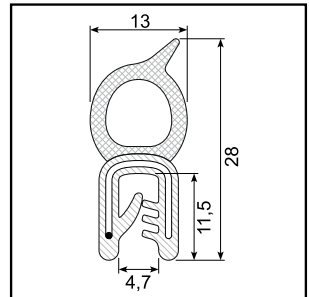

Edge trim: EPDM co-ex
Grip range: 1 - 3,5 mm
Hardness: SH 70 / density 0,55
Insert: 26 x 0,76 mm wire
Min. order: 5.500 mtr.

33.025

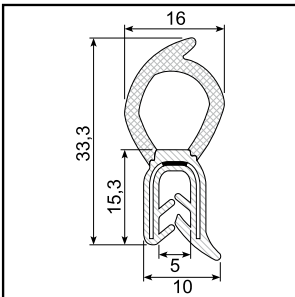

Edge trim: EPDM co-ex
Grip range: 1,5 - 3,5 mm
Hardness: SH 70 / density 0,55
Insert: 27 x 0,47 mm steel

33.377

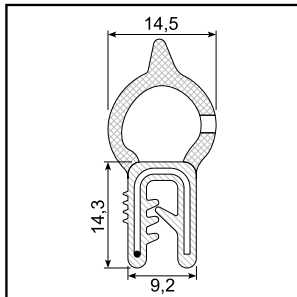

Edge trim: EPDM co-ex
Grip range: 1 - 3,5 mm
Hardness: SH 70 / density 0,75
Insert: 27 mm wire
Min. order: 4.000 mtr.

33.463

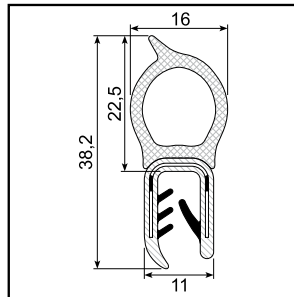

Edge trim: PVC+bi / sponge rubber
Grip range: 4 - 6 mm
Hardness: SH78/57 density 0,55
Insert: 31 x 0,5 mm steel

33.378

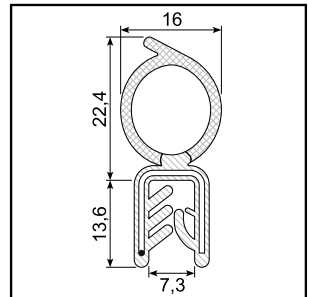

Edge trim: EPDM co-ex
Grip range: 1,5 - 5 mm
Hardness: SH 70 / density 0,55
Insert: 33 mm wire
Min. order: 3.000 mtr.

33.379

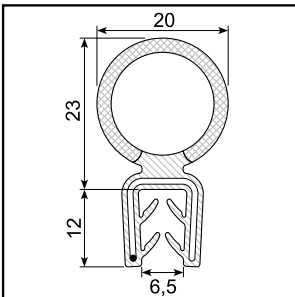

Edge trim: EPDM co-ex
Grip range: 2,5 - 5 mm
Hardness: SH 70 / density 0,55
Insert: 33 mm wire
Min. order: 4.000 mtr.

33.380

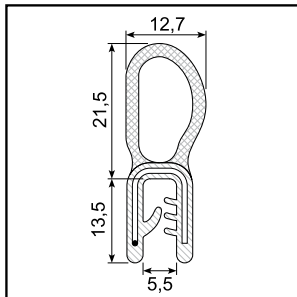

Edge trim: EPDM co-ex
Grip range: 2 - 4 mm
Hardness: SH 70 / density 0,55
Insert: 29 mm wire
Min. order: 4.000 mtr.

33.355B

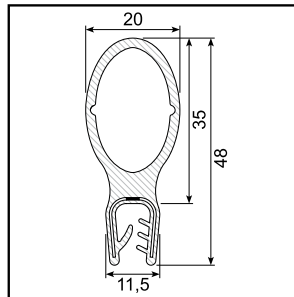

Edge trim: EPDM solid ballon
Grip range: 3 - 5 mm
Hardness: SH 60
Insert: 31 x 0,5 mm steel unbroken

33.374

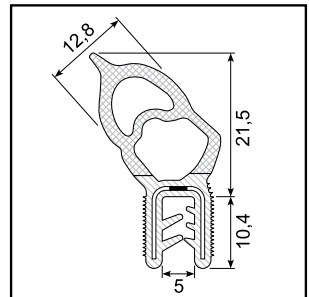

Edge trim: EPDM co-ex
Grip range: 1,5 - 4 mm
Hardness: SH 70 / density 0,55
Insert: 27 x 0,47 mm steel
Min. order: 2.500 mtr.

33.375

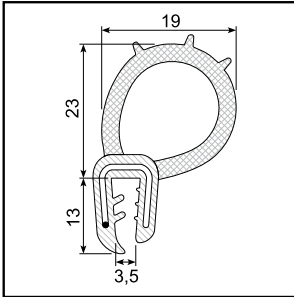

Edge trim: EPDM co-ex
Grip range: 4 - 5 mm
Hardness: SH70 / density 0,6 - 0,85
Insert: 27 mm wire
Min. order: 3.000 mtr.

33.431A

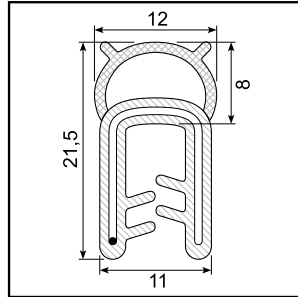

Edge trim: Silicone light grey
RAL7035
Grip range: 2 - 4 mm
Hardness: SH 60 / 60 solid ballon
Insert: 31 x 0,76 mm wire
Heat resistant 200°C

33.373F

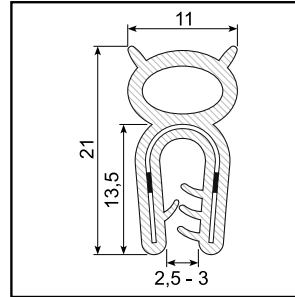

Edge trim: EPDM co-ex
Grip range: 0,8 - 3 mm
Hardness: SH 65 / density 0,6
Insert: 29 x 0,5 mm steel
Min. order: 4.000 mtr.
Flame retardent Din 5510-2

33.373

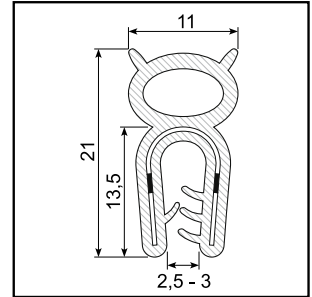

Edge trim: EPDM co-ex
Grip range: 0,8 - 3 mm
Hardness: SH 65 / density 0,6
Insert: 29 x 0,5 mm steel
Min. order: 4.000 mtr.

33.371E EMV - EMC - EMI

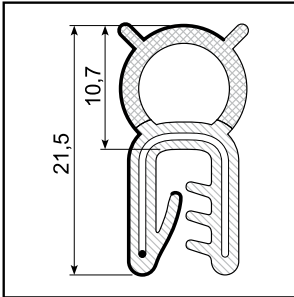

Edge trim: EPDM co-ex
Grip range: 1 - 3 mm
Hardness: SH 70 / density 0,55
Insert: Wire
Electromagnetic compatibility

33.403

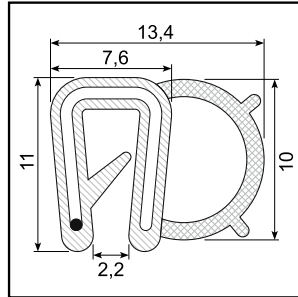

Edge trim: EPDM co-ex
Grip range: 1 - 2 mm
Hardness: SH 70 / density 0,55
Insert: 20 x 0,76 mm wire
Min. order: 5.500 mtr.

33.404

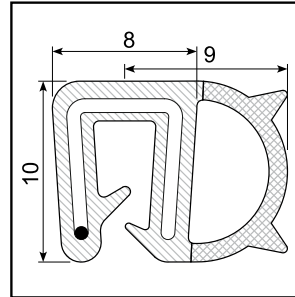

Edge trim: EPDM co-ex
Grip range: 1 - 2,5 mm
Hardness: SH 60 / density 0,55
Insert: 20 x 0,76 mm wire
Min. order: 5.500 mtr.

33.405

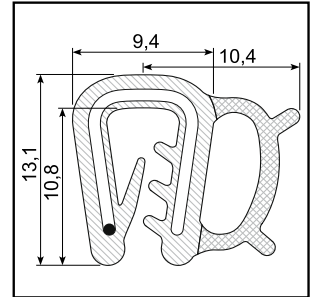

Edge trim: EPDM co-ex
Grip range: 1 - 2 mm
Hardness: SH 70 / density 0,55
Insert: Wire
Min. order: 5.500 mtr.

33.406

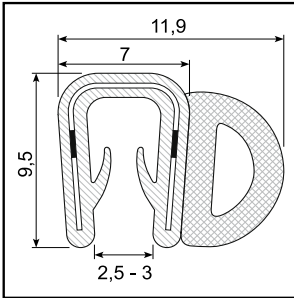

Edge trim: EPDM co-ex
Grip range: 2 - 3 mm
Hardness: SH 65
Insert: 20 x 0,5 mm steel
Min. order: 4.000 mtr.

33.407X

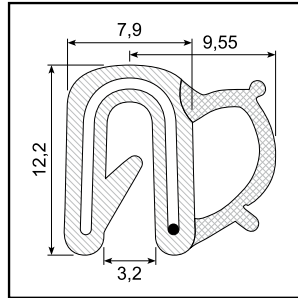

Edge trim: EPDM co-ex
Grip range: 0,8 - 2,5 mm
Hardness: SH 60 / density 0,55
Insert: 22 x 0,75 mm wire

33.408X

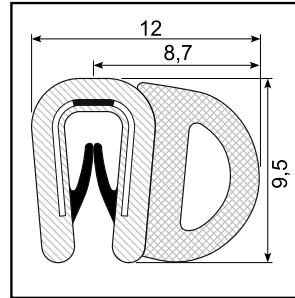

Edge trim: PVC+bi / sponge rubber
Grip range: 1 - 2 mm
Hardness: SH 78 / 57
density 0,55
Insert: 16 x 0,3 mm steel

33.395A

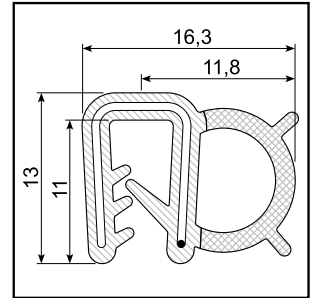

Edge trim: EPDM co-ex
Grip range: 2 mm
Hardness: SH 60 / density 0,6
Insert: 26 x 0,75 mm wire

33.395X

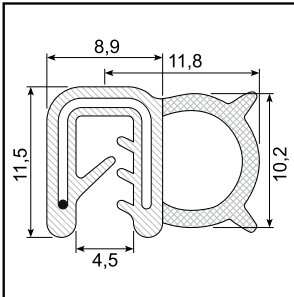

Edge trim: EPDM co-ex
Grip range: 1 - 3 mm
Hardness: SH 70 / density 0,55
Insert: Wire

33.397F

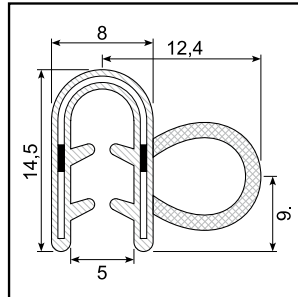

Edge trim: EPDM co-ex
Grip range: 2 - 3 mm
Hardness: SH 65 / density 0,6
Insert: 29 x 0,5 mm steel
Min. order: 4.000 mtr.
Flame retardent Din 5510-2

33.397

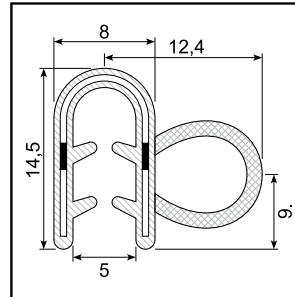

Edge trim: EPDM co-ex
Grip range: 2 - 3 mm
Hardness: SH 65 / density 0,6
Insert: 29 x 0,5 mm steel
Min. order: 4.000 mtr.

33.396

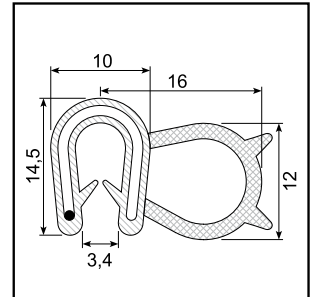

Edge trim: EPDM co-ex
Grip range: 1 - 3 mm
Hardness: SH 70
density 0,6 - 0,85
Insert: 27 mm wire

33.444X

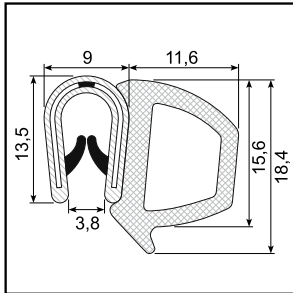

Edge trim: PVC + sponge rubber
Grip range: 1 - 3,5 mm
Hardness: SH75/75/density 0,6 - 0,86
Insert: 26 x 0,47 mm steel
Red lips

33.445

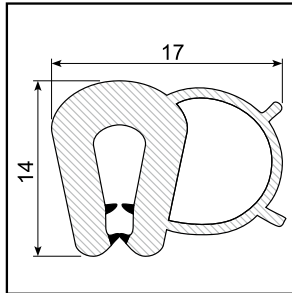

Edge trim: TPE+bi
Grip range: 1 - 4,5 mm
Hardness: SH 80 / 65 - 70
Insert: Without steel
On demand

33.9779

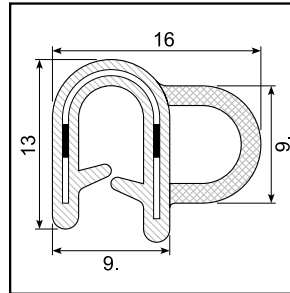

Edge trim: EPDM co-ex
Grip range: 1,5 - 3 mm (1 - 4 mm)
Hardness: SH 70 / density 0,65
Insert: 25 x 0,5 mm steel

33.372X

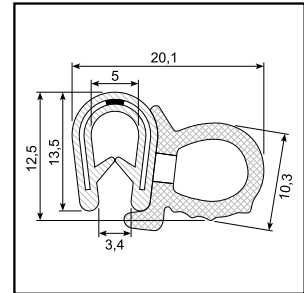

Edge trim: PVC + spongerubber
Grip range: 1 - 3,5 mm
Hardness: SH75 / 75 / density 0,6 - 0,85
Insert: 22 x 0,47 mm steel

33.398

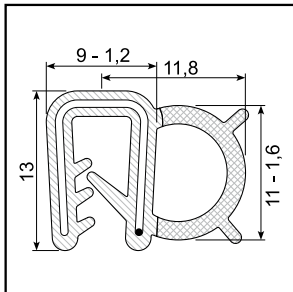

Edge trim: NBR co-ex
Grip range: 2 mm
Hardness: SH 60 / density 0,55
Insert: 27 x 0,76 mm wire
Oil-resistant

33.339X

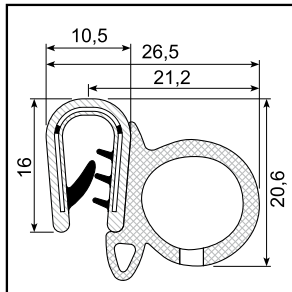

Edge trim: PVC+bi/ sponge rubber
Grip range: 2,5 - 4 mm
Hardness: SH 78 / 65
Insert: Steel

33.320

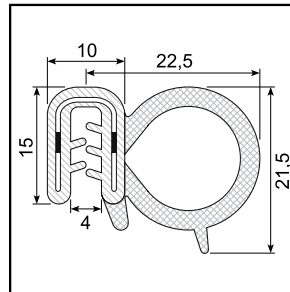

Edge trim: EPDM co-ex
Grip range: 1 - 2,5 mm
Hardness: SH 65 / density 0,6
Insert: 29 x 0,5 mm steel
Min. order: 4.000 mtr.

33.454X

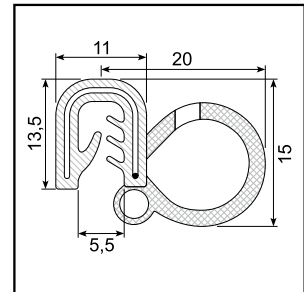

Edge trim: EPDM co-ex
Grip range: 2 mm
Hardness: SH 70 / Density 0,55
Insert: 27 x 0,76 mm wire

33.321

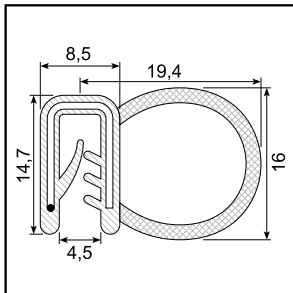

Edge trim: EPDM co-ex
Grip range: 1 - 3,5 mm
Hardness: SH70/density 0,6 - 0,85
Insert: 27 mm wire
Min. order: 5.000 mtr.

33.450W

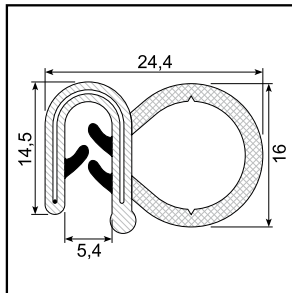

Edge trim: CR co-ex
Grip range: 1,5 - 4 mm
Hardness: SH 70 / density 0,6
Insert: 29 x 0,75 mm wire
Conditional oil-resistant

33.450NBR

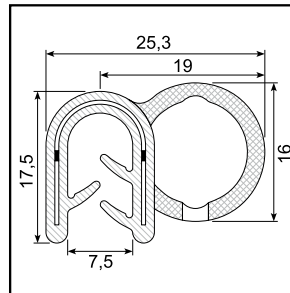

Edge trim: NBR co-ex
Oil-resistant
Grip range: 4 - 6 mm (3 - 6 mm)
Hardness: SH 70 / density 0,55
Insert: 34 x 0,5 mm steel

33.322F

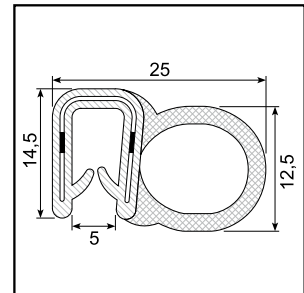

Edge trim: EPDM co-ex
Grip range: 1,5 - 3 mm
Hardness: SH 65 / density 0,6
Insert: 29 x 0,5 mm steel
Min. order: 4.000 mtr.
Flame retardant Din 5510-2

33.322

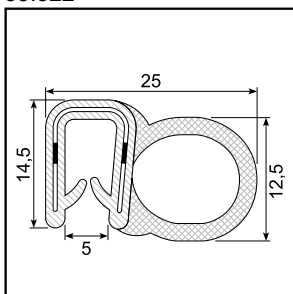

Edge trim: EPDM co-ex
Grip range: 1,5 - 3 mm
Hardness: SH 65 / density 0,6
Insert: 29 x 0,5 mm steel
Min. order: 4.000 mtr.

33.323

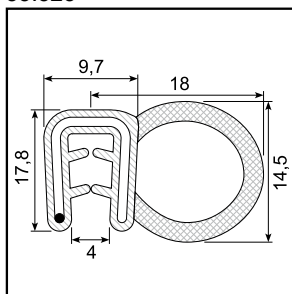

Edge trim: EPDM co-ex
Grip range: 1,5 - 3,5 mm
Hardness: SH70/density 0,6 - 0,85
Insert: 27 mm wire
Min. order: 3.000 mtr.

33.324CR

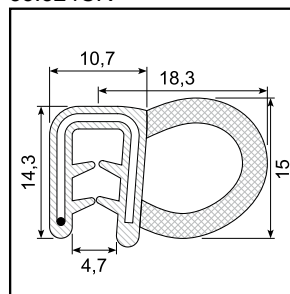

Edge trim: CR co-ex
Grip range: 1 - 3,5 mm
Hardness: SH70 / density 0,6 - 0,85
Insert: 29 mm wire
Min. order: 4.000 mtr.
Conditional oil-resistant

33.338

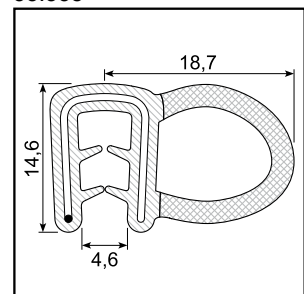

Edge trim: EPDM co-ex
Grip range: 1,5 - 3 mm
Hardness: SH 60 / density 0,55
Insert: 29 x 0,76 mm wire
Min. Order: 5.000 mtr.

33.335

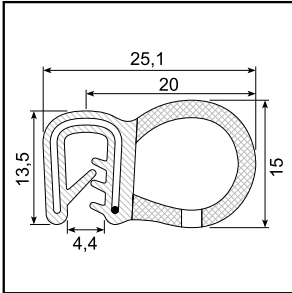

Edge trim: EPDM co-ex
Grip range: 1,5 - 3,5 mm
Hardness: SH70/density 0,6 - 0,85
Insert: 27 mm wire
Min. order: 5.000 mtr.

33.020

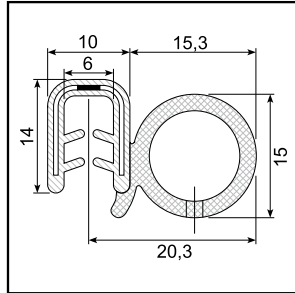

Edge trim: EPDM co-ex
Grip range: 1,5 - 3 mm
Hardness: SH 70 / density 0,55
Insert: 27 x 0,47 mm steel

33.022

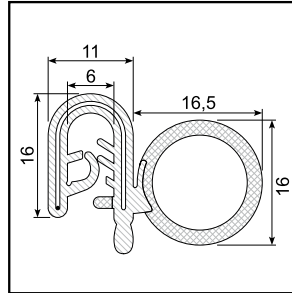

Edge trim: EPDM co-ex
Grip range: 1,5 - 3 mm (1,5 - 4 mm)
Hardness: SH 70 / density 0,6
Insert: 33 mm wire

33.326

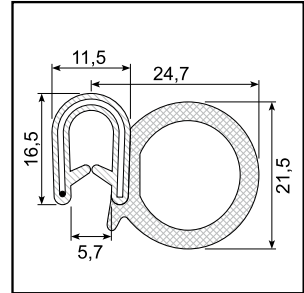

Edge trim: EPDM co-ex
Grip range: 1,5 - 4 mm
Hardness: SH70/density 0,6 - 0,85
Insert: 33 mm wire
Min. order: 3.000 mtr.

33.327

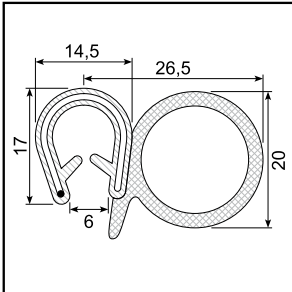

Edge trim: EPDM co-ex
Grip range: 6 - 8 mm
Hardness: SH70 / density 0,6 - 0,85
Insert: 33 mm wire
Min. order: 3.000 mtr.

33.328

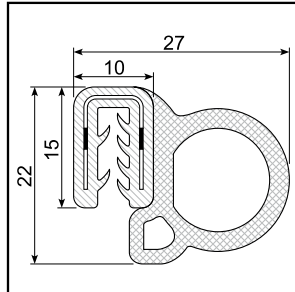

Edge trim: EPDM co-ex
Grip range: 1,5 - 2,5 mm
Hardness: SH 65 / density 0,6
Insert: 29 x 0,5 mm steel
Min. order: 4.000 mtr.

33.457S

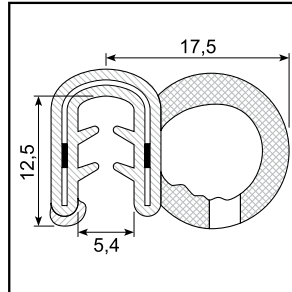

Edge trim: EPDM co-ex
Grip range: 5 - 6 mm
Hardness: SH 70 / density 0,6
Insert: 29 x 0,5 mm steel

33.329

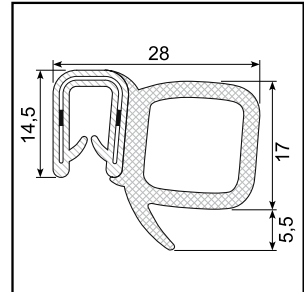

Edge trim: EPDM co-ex
Grip range: 1,5 - 3 mm
Hardness: SH 65 / density 0,6
Insert: 29 x 0,5 mm steel
Min. order: 4.000 mtr.

33.329F

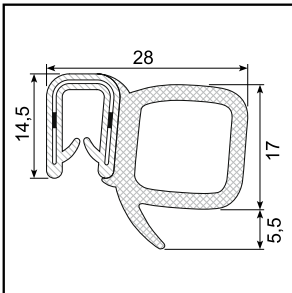

Edge trim: EPDM co-ex
Grip range: 1,5 - 3 mm
Hardness: SH 65 / density 0,6
Insert: 29 x 0,5 mm steel
Min. order: 4.000 mtr.
Flame retardent Din 5510-2

33.453X

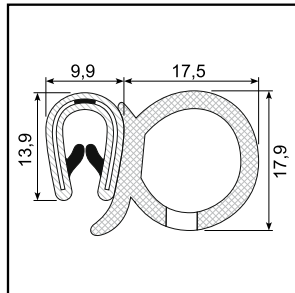

Edge trim: PVC + sponge rubber
Grip range: 1 - 3,5 mm
Hardness: SH75/75 density 0,6 - 0,85
Insert: 26 x 0,47 mm steel

33.330

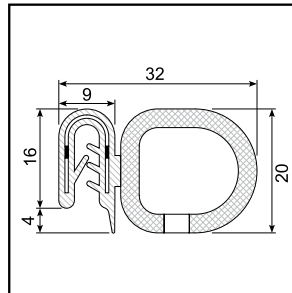

Edge trim: EPDM co-ex
Grip range: 1 - 3 mm
Hardness: SH 65 / density 0,6
Insert: 29 x 0,5 mm steel
Min. order: 3.000 mtr.

33.331

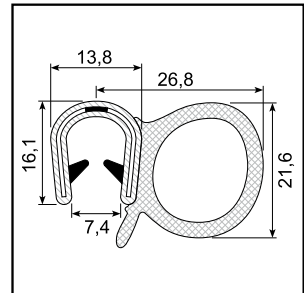

Edge trim: PVC + sponge rubber
Grip range: 6 - 8 mm
Hardness: SH75/75 density 0,6 - 0,85
Insert: 30 x 0,47 mm steel
Min. order: 3.000 mtr.
White lips

33.332

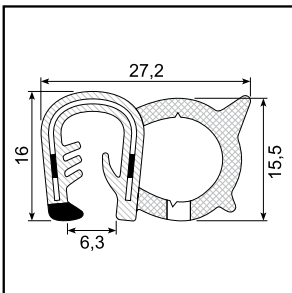

Edge trim: EPDM co-ex
Grip range: 4 - 6 mm
Hardness: SH70 / density 0,65
Insert: 32 x 0,5 mm steel unbroken
Min. order: 4.000 mtr

33.024

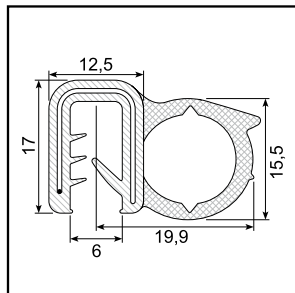

Edge trim: EPDM co-ex
Grip range: 2 - 4 mm (2 - 5 mm)
Hardness: SH 70 / density 0,55
Insert: 33 mm wire

33.457

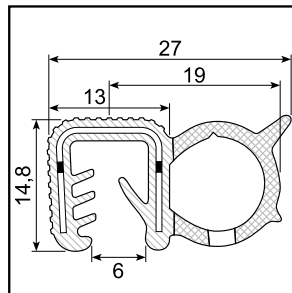

Edge trim: EPDM co-ex
Grip range: 5 - 6 mm
Hardness: SH 60 / density 0,6
Insert: 32 x 0,6 mm steel unbroken

33.457ST

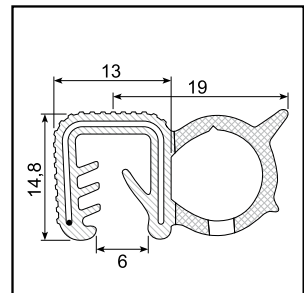

Edge trim: EPDM co-ex
Grip range: 5 - 6 mm
Hardness: SH 60 / density 0,55
Insert: 31 x 0,76 mm wire

33.457D

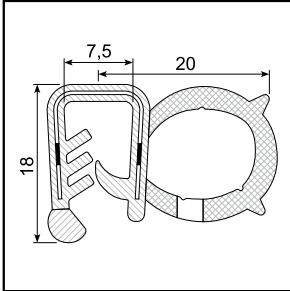

Edge trim: EPDM co-ex
Grip range: 1,5 - 3 mm
Hardness: SH 70 / density 0,55
Insert: 27 x 0,47 mm steel

33.470

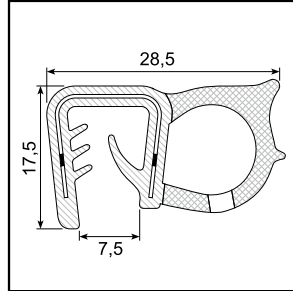

Edge trim: EPDM co-ex
Grip range: 5 - 9 mm
Hardness: SH 70 / density 0,6
Insert: 36 x 0,5 mm steel

33.023

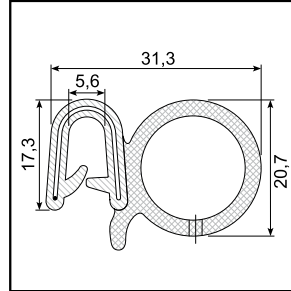

Edge trim: EPDM co-ex
Grip range: 1,5 - 4 mm (2 - 5 mm)
Hardness: SH 70 / density 0,55
Insert: 33 mm wire

33.449

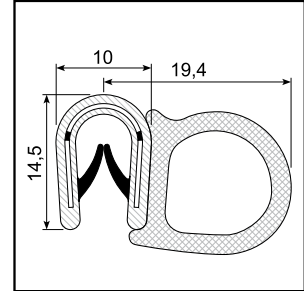

Edge trim: PVC+bi / sponge rubber
Grip range: 1 - 4 mm
Hardness: SH78/57 / density 0,55
Insert: 26 x 0,5 mm steel

33.333

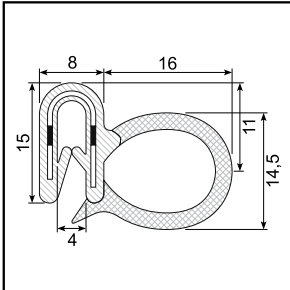

Edge trim: EPDM co-ex
Grip range: 1 - 3 mm
Hardness: SH 65 / density 0,6
Insert: 29 x 0,5 mm steel
Min. order: 4.000 mtr.

33.336

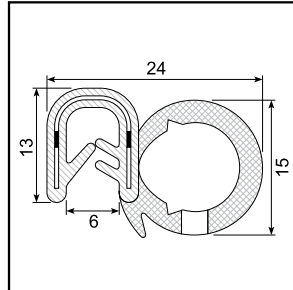

Edge trim: EPDM co-ex
Grip range: 1,5 - 3,5 mm
Hardness: SH 70 / density 0,55
Insert: 26 x 0,5 mm steel
Min. order: 5.000 mtr.

33.337

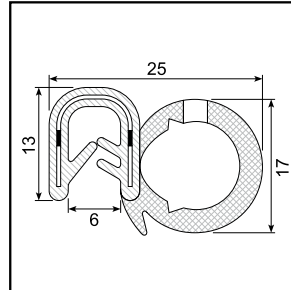

Edge trim: EPDM co-ex
Grip range: 1,5 - 3,5 mm
Hardness: SH 70 / density 0,55
Insert: 26 x 0,5 mm steel
Min. order: 5.000 mtr.

33.452X

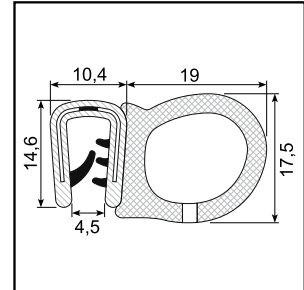

Edge trim: PVC+bi / sponge rubber
Grip range: 2 - 4 mm
Hardness: SH 78 / 65
density 0,65 - 0,75
Insert: 29 x 0,48 mm

33.452T

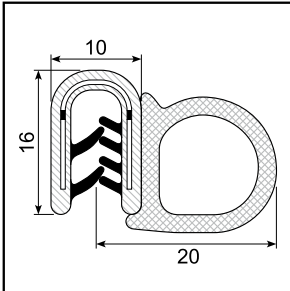

Edge trim: PVC+bi / sponge rubber
Grip range: 1 - 4 mm
Hardness: SH 78 / 57 density 0,6
Insert: 31 x 0,5 mm steel

33.451X

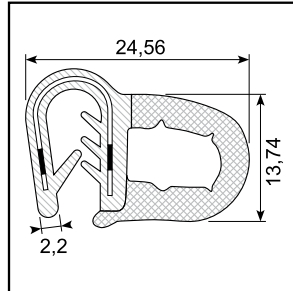

Edge trim: EPDM co-ex
Grip range: 2 - 5 mm
Hardness: SH 70 / density 0,6
Insert: Steel

33.451E

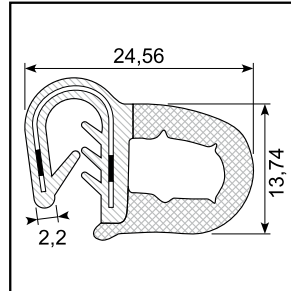

Edge trim: EPDM co-ex
Grip range: 2 - 5 mm
Hardness: SH 70 / density 0,6
Insert: Steel

33.451CR

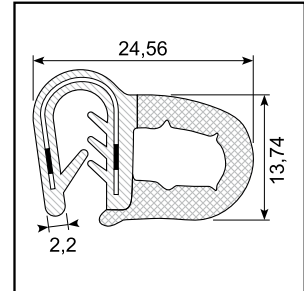

Edge trim: CR co-ex
Grip range: 2 - 5 mm
Hardness: SH 70 / density 0,6
Insert: Steel
Conditional oil-resistant

33.447

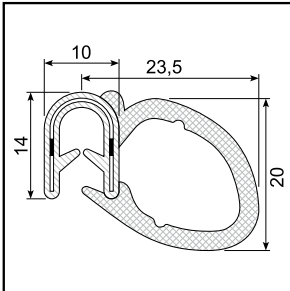

Edge trim: EPDM co-ex
Grip range: 2,5 - 5 mm
Hardness: SH 70 / density 0,6
Insert: Steel

33.452R

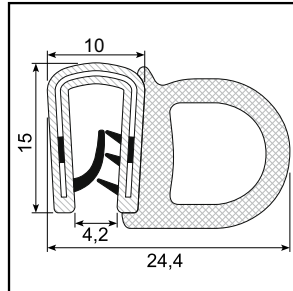

Edge trim: PVC+bi / sponge rubber
Grip range: 2 - 4 mm
Hardness: SH 78 / 65
density 0,65 - 0,75
Insert: 29 x 0,48 mm stainless steel

30.12116

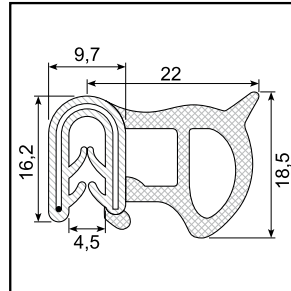

Edge trim: EPDM co-ex
Grip range: 1 - 4 mm
Hardness: SH 70 / density 0,6 - 0,85
Insert: 29 mm wire
Min. order: 3.000 mtr.

33.464

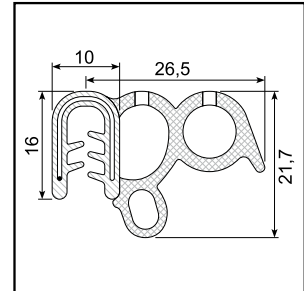

Edge trim: EPDM co-ex
Grip range: 1,5 - 3,5 mm
Hardness: SH 70 / density 0,6
Insert: 31 x 0,75 mm wire

33.456

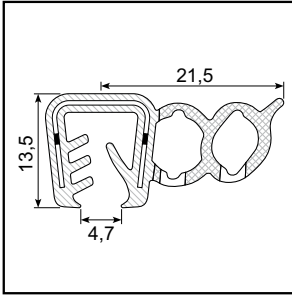

Edge trim: EPDM co-ex
Grip range: 5 - 6 mm
Hardness: SH 70 / density 0,6
Insert: 30 x 0,6 mm steel

33.334

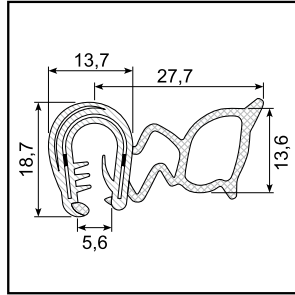

Edge trim: EPDM co-ex
Grip range: 2 - 4 mm
Hardness: SH 70 / density 0,6 - 0,85
Insert: 33 mm steel
Min. order: 3.000 mtr.

33.458X

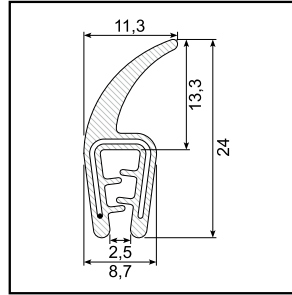

Edge trim: EPDM solid lip
Grip range: 1 - 2,5 mm
Hardness: SH 60
Insert: 26 x 0,76 mm wire

33.465X

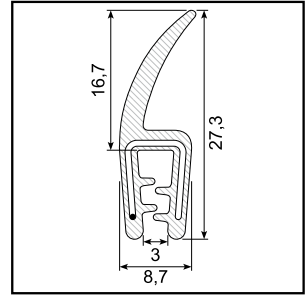

Edge trim: EPDM solid lip
Grip range: 1 - 3 mm
Hardness: SH 60
Insert: 26 x 0,76 mm wire

33.459

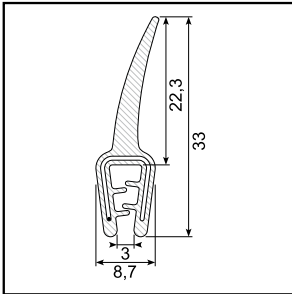

Edge trim: EPDM solid lip
Grip range: 1 - 2,5 mm
Hardness: SH 60
Insert: 26 x 0,76 mm wire

33.459P

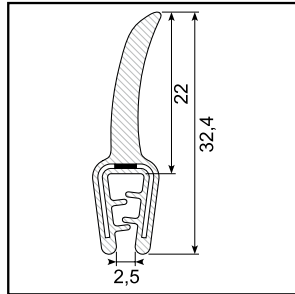

Edge trim: PVC solid lip
Grip range: 1 - 2,5 mm
Hardness: SH 57
Insert: 24 x 0,5 mm steel unbroken

33.473

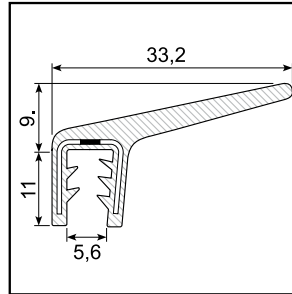

Edge trim: EPDM solid lip
Grip range: 2 - 5 mm
Hardness: SH 70
Insert: 27 x 0,47 mm steel
Min. order: 4.000 mtr.

33.471

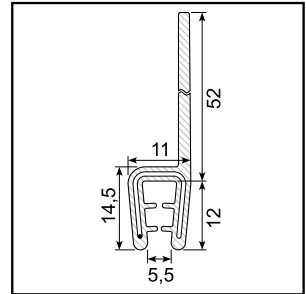

Edge trim: EPDM solid lip
Grip range: 3 - 5 mm
Hardness: SH 60 solid lip
Insert: 29 x 0,76 mm wire

33.472

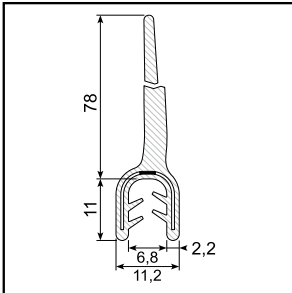

Edge trim: EPDM solid lip
Grip range: 2 - 4 mm
Hardness: SH 70
Insert: 29 x 0,5 mm unbroken

33.460-6+6A / 33.460-4 / 33.460-2

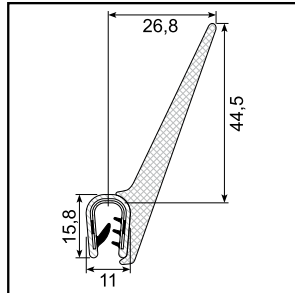

Edge trim: PVC+bi / sponge rubber
Grip range: 1,5 - 2,5 mm / 2 - 4 mm / 4 - 6 mm
Hardness: SH78 / 57 / density 0,6
Insert: 31 x 0,5 mm steel

33.460-2C

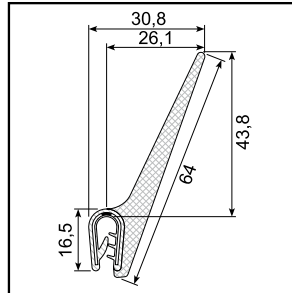

Edge trim: EPDM co-ex
Grip range: 1 - 2,5 mm
Hardness: SH 70 / density 0,6
Insert: 31 x 0,5 mm steel unbroken

33.475

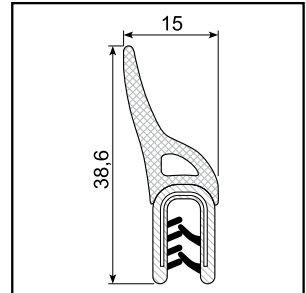

Edge trim: PVC+bi/sponge rubber
Grip range: 2 - 4 mm
Hardness: SH 78/57 density 0,55
Insert: Steel

33.443

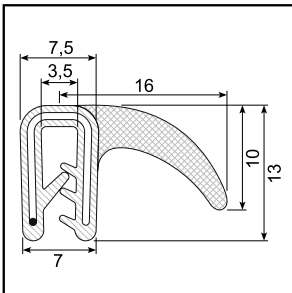

Edge trim: EPDM co-ex
Grip range: 1 - 2 mm
Hardness: SH 70 / density 0,55
Insert: Wire
Min. order: 5.500 mtr.

33.467

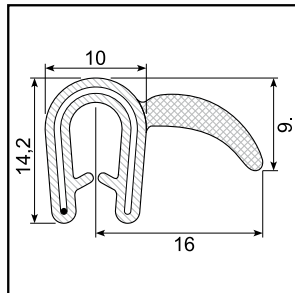

Edge trim: EPDM co-ex
Grip range: 1,5 - 3,5 mm
Hardness: SH 70 / density 0,65
Insert: 29 x 0,76 mm wire

33.474

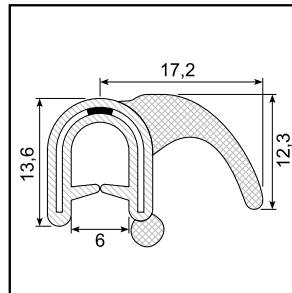

Edge trim: EPDM co-ex
Grip range: 2 - 5 mm
Hardness: SH 70 / density 0,6 - 0,85
Insert: 27 mm steel
Min. order: 4.000 mtr.

33.436

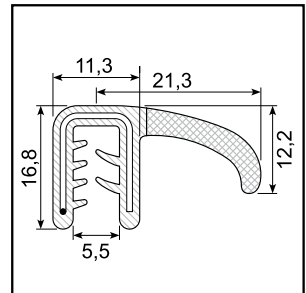

Edge trim: EPDM co-ex
Grip range: 2 - 4 mm
Hardness: SH 70 / density 0,6 - 0,85
Insert: 33 mm wire